

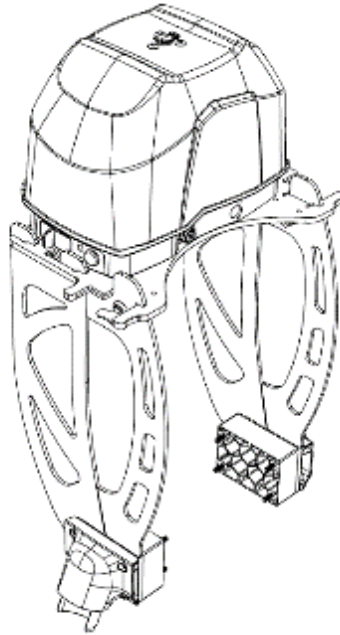

PRS-M300 for DJI M300 RTK

Version 2.0



Using this Manual

1. Revision Notes

Revision #	Date	Revision Description
1.0	November 1 st , 2020	- Initial Internal Release
1.1	February 26 th , 2021	- ASTM Revision - Updated FTS through OSDK - Updated Specifications - Updated Attachment Bracket
1.2	April 20 th , 2021	- Product Description - LiPo Battery Information - ATS MDA - Arming the Manual Triggering Device - Terminology - Initial ASTM Performance Data
1.3	May 6 th , 2021	- Final ASTM Performance Data
1.4	May 14 th , 2021	- Revised Flight Termination System Firmware Configuration
1.5	May 22 nd , 2021	- Updated Operational Limitations - Revised Integration Steps
1.6	August 23 rd , 2021	- Revised Limitations' Language to Notify Users Not to Switch Between Position Mode and Automated Flight Modes Mid Flight
1.7	October 24 th , 2021	- IMU Calibration Instructions
2.0	April 14, 2022	- Revised Firmware Update Method for V3 Release - Added Status Indication for Sensor Error

2. Legends



Warning



Important



Tips

FOR THE MOST RECENT VERSION OF THE USER MANUAL, PLEASE GO TO:
<https://www.avss.co/products/prs-for-dji-m300-rtk/>

Using this Manual	2
1. Revision Notes	2
2. Legends	2
Disclaimer	5
Terms, Acronyms, & Abbreviations	6
Safety Instructions	7
Limitations	8
1. Operational & Environmental Conditions	8
PRS-M300 Overview	9
1. First Time Setup	9
2. General Use	9
Features, Specifications, Testing, & Compatibility	10
1. Features	10
2. Specifications	11
3. Payloads	12
Warranty	13
What's in the Box:	14
1. Parts Included	14
System Overview	15
1. Parachute Recovery System	15
2. Attachment Bracket	16
3. Flight Termination System – Through OSDK	17
4. Manual Triggering Device	18
Installation	19
1. Electronic Module	19
2. Parachute Pod™	20
3. Attachment Bracket	21
4. Flight Termination System Firmware Configuration	26
Battery & Charging	34
1. Battery Safety	34
2. Battery Charging	34
3. Changing Electronic Module Battery	35
Firmware & SD Card	36

1. MicroSD Card	36
2. Firmware Updates	37
Status Indications	39
1. PRS-M300 Indications	39
2. Manual Triggering Device Status Indication	40
3. Manual Triggering Device Synchronization	40
Operating Procedures	41
1. Hangar Checklist	41
2. Installation Checklist	41
3. Pre-Flight Checklist	41
4. In-Flight Checklist	42
5. Landing Checklist	42
6. Post-Flight Checklist (No Deployment)	42
7. Deployment Checklist	42
8. Post-Flight Checklist (With Deployment)	42
Maintenance & Care	43
1. Post-Flight (Monthly)	43
2. Transportation	43
3. Storage	43
4. Extended Storage Considerations	43
Frequently Asked Questions	44
Parachute Pod™ Deployment Procedures	45
Customer Support	46
Appendix A: DJI M300 RTK & Payload References	47
Appendix B: IMU Calibration Instructions	48

Disclaimer

- You must read the ENTIRE user manual to become familiar with the features of this product before operation. Failure to operate the product as instructed by the user manual may result in damage to the product or personal property and can cause serious injury. Failure to operate the product as instructed may also void your warranty.
- This product has been designed for and should only be used by qualified professionals only.¹
- This product is designed to increase the safety of both people and property on the ground during DJI M300 RTK operations while potentially helping DJI M300 RTK operators meet compliance requirements. However, this product is not a replacement for safe operating practices and should serve only as a last resort in the event of an emergency.
- Before use, you shall refer to the DJI M300 RTK manufacturers' documentation to determine if this product complies with specific operating requirements and warranty conditions of the DJI M300 RTK. Failure to comply with the operating requirements of this product and/or DJI M300 RTK manufacturer product may result in damage to the DJI M300 RTK, damage to nearby property, harm to bystanders, and/or cause serious injury.
- Always use proper judgment when attempting to mitigate risks and/or danger in emergencies. Do not make or attempt any alterations or adjustments to this product or its use as it could result in serious injury, or damage to the product or other property and it will void the warranty.
- AVSS – Aerial Vehicle Safety Solutions Inc. (AVSS) assumes no liability and/or ownership of any failure event that may occur while the system is attached to a DJI M300 RTK. The use of AVSS products is at the risk of the user.
- Do not store the PRS-M300 and/or any of the associated parts and accessories in any extreme cold, hot or humid environments.
 - Less than 3 months: -20° to +45° C
 - More than 3 months: +22° to +28° C
- This document and the information contained herein are proprietary and commercially confidential to AVSS. It is prohibited to use, disclose, reproduce, distribute, or use this user manual other than persons for which purchased the product.



THIS USER MANUAL MAY BE UPDATED AT ANY POINT AND WITHOUT NOTIFICATION. BEFORE USE, READ, IN ITS ENTIRETY, THE MOST RECENT VERSION OF THIS USER MANUAL TO UNDERSTAND ALL PROCEDURES, RISKS, AND RESTRICTIONS ASSOCIATED WITH THIS PRODUCT BEFORE OPERATING.

¹ Professional qualifications are determined by the jurisdiction/country in which the commercial DJI M300 RTK is operating.

Terms, Acronyms, & Abbreviations

Terms & Definitions	
AGL	Above Ground Level.
ATS	Autonomous Triggering System that is independent of any flight critical system of the DJI M300 RTK that will detect and initiate parachute deployment upon detection of a critical failure of the DJI M300 RTK during flight.
Authorized Dealer	An AVSS approved distribution partner who sells the PRS-M300.
Drone	When referring to a DJI M300 RTK, other relevant terms include Aircraft, RPAS, sUAS, UAS, and UAV.
End-User	The owner of the PRS-M300 who had purchased the system from an AVSS Authorized Dealer.
FTS	Flight Termination System is a device that will disable the propulsion system of the DJI M300 RTK.
IP Rating	Ingress Protection Rating.
LiPo	Lithium-Polymer (Chemistry of battery).
Manual Triggering Device	The manual triggering device, initiated by pressing the triggering button, initiates the deployment of the parachute recovery system at the discretion of the pilot in command.
Minimum Deployable Altitude	The lowest altitude at which the PRS-M300 is rated to deploy successfully.
Parachute Pod™	This refers to the replaceable Parachute Pod™ that contains the parachute of the AVSS PRS-M300.
Position Mode	The PRS-M300 shall be used only in P-mode (Positioning): P-mode works best when the GPS signal is strong. The DJI M300 RTK utilizes GPS and Forward and Downward Vision Systems to locate itself, automatically stabilize, and navigate between obstacles. Complete details can be found at www.DJI.com .
PRS	Parachute Recovery System.
Shall	“shall” versus “should” versus “may”, v—use of the word “shall” implies that a procedure or statement is mandatory and shall be followed to comply with this specification, “should” implies recommended, and “may” implies optional at the discretion of the supplier, manufacturer, or operator.

Safety Instructions

Eye Protection	As with any system designed to launch a mass at high velocity, precautions shall be taken to prevent potential injury.
Never point the Parachute Pod™ towards anyone or anything	While the PRS-M300 includes features to prevent unintentional deployments, users shall be aware that the Parachute Pod™ is launched vertically. It is recommended that the operator maintains a clear area of at least 5 meters after the system has been powered.
Disarming Manual Trigger Device	Always disarm the Manual Trigger Device before approaching the DJI M300 RTK after a landing or in the event of an aborted takeoff.
Ensure PRS-M300 is DISARMED before moving it	Do not pick up the PRS-M300 when it is armed because the sensors may interpret the movements as an in-flight failure. Wait five to ten seconds for the Autonomous Triggering System to disarm.
Error Status	The system should not be used unless it is indicated that no errors are present. The system will not arm itself nor deploy in a failure scenario unless it has initialized successfully.
Low Battery	The PRS-M300 requires enough battery power to operate. Although the PRS-M300 can draw power from the DJI M300 RTK as a backup if the battery becomes low during a flight, this feature is not to be used as a substitute for charging the battery prior to flight.
Parachute Pod™ Repacking	Only parachutes packed by AVSS are compliant. The Parachute Pod™ shall be repacked or replaced annually only by AVSS. You will no longer be compliant and will void the warranty if you attempt or repack the Parachute Pod™.
Payload Configuration	Always follow DJI's maximum specified takeoff weight when adding payloads to the DJI M300 RTK (See Compatibility & Payloads sub-section for a list of compatible payload configurations).
Position Mode and Flight Mode Changes	The Autonomous Triggering System is designed to automatically detect abnormal flight behaviors. Flying in a controlled manner and avoiding erratic maneuvers ensures that the PRS-M300 can more accurately distinguish between pilot commands and loss of control. Do not change the flight mode mid-flight as the DJI M300 RTK can have a hard/abrupt braking maneuver that can exceed the maximum "30°-degree pitch angle (P-mode, Forward Vision System enabled: 25°)" ² .
Rules and Regulations	Pilots shall follow the rules and regulations put in place by civil aviation or government bodies in their operating regions.
Li-Po Battery Warning	The PRS-M300 utilizes Li-Po batteries. Li-Po batteries are volatile and can cause fires. The user must take the necessary precautions when charging the PRS-M300.

² <https://www.dji.com/ca/matrice-300/specs>

Limitations

1. Operational & Environmental Conditions

- DJI M300 RTK Flight Mode = Position Mode
- DJI M300 RTK Maximum Tilt Angle = 30° Degrees
- Maximum Take Off Weight = 9.20 kg (20.28 lbs)
- Minimum Deployable Altitude at 7.70 kg = 44.6 m (146.33 ft)
- Minimum Deployable Altitude at 9.20 kg = 50.8 m (166.67 ft)
- Autonomous Triggering System Arming Height = 43 m (141.08 ft)
- Manual Triggering Device Range = <2 km (<1.24 mi)
- Temperature Range = -20°C to +45°C (-4°F to 113°F)
- Maximum Wind Resistance = 15 m/s (49.21 fps)



ONLY FLY THE PRS-M300 IN POSITION MODE.

DO NOT CHANGE / SWITCH FLIGHT MODES FROM POSITION MODE TO AUTOMATED FLIGHT MODES OR AUTOMATED FLIGHT MODES TO POSITION MODES MID FLIGHT AS THE DJI M300 RTK MAY MAKE AN ABRUPT STOP OR MANEUVER AND EXCEED THE “30°-DEGREE PITCH ANGLE (P-MODE, FORWARD VISION SYSTEM ENABLED: 25°)”.



IF YOU UPDATE THE FIRMWARE ON THE DJI M300 RTK, ALL EXISTING PRS-M300 OSDK SETTINGS WILL BE REMOVED. THEREFORE, AFTER COMPLETING A FIRMWARE UPDATE, YOU MUST PERFORM THE FIRST TIME & AFTER FIRMWARE UPDATES PROCEDURES (SEE “FIRST TIME USE & AFTER FIRMWARE CONFIGURATION” SECTION)



IF THE PARACHUTE IS DEPLOYED IN HIGH WINDS, THE PARACHUTE CAN DRIFT. THE PILOT MUST CONSIDER DRIFT ZONES AND THE CONSEQUENCES IN THEIR RISK ASSESSMENT.



LEAVING THE PRS-M300 ON FOR A PROLONGED PERIOD BEFORE TAKING OFF CAN CAUSE IT TO ARM IF ENVIRONMENTAL CONDITIONS ARE CHANGING (E.G., BAROMETER DRIFT).



IF THE PRS-M300 IS INVOLVED IN A MAJOR CRASH, DO NOT REUSE THE PRS-M300 WITHOUT CONTACTING AVSS'S CUSTOMER SUPPORT AND SPEAKING WITH A REPRESENTATIVE BEFORE THE NEXT FLIGHT.

PRS-M300 Overview

The PRS-M300 is composed of five (5) main components:

1. The Electronics Module, which houses the battery, sensors, radio, and controller. These electronics also control the autonomous triggering system that will deploy the parachute.
2. The swappable Parachute Pod™, which contains a compressed spring and a folded parachute.
3. The Flight Termination System Module, a cable adapter and module that enables the Electronics Module to communicate with the DJI M300 RTK's OSDK for motor shutoff.
4. The Bracket, which attaches the PRS-M300 to the DJI M300 RTK and allows for easy removal.
5. The Manual Triggering Device, which allows the user to manually initiate a parachute deployment when desired by pressing on the red triggering button.

1. First Time Setup

When the user receives the product, the Electronics module comes mounted to the top plate of the bracket with a Parachute Pod™ already attached. For a first-time installation, the user must remove the landing gear brackets on the DJI M300 RTK, place an aluminum spacer block in between and remount the landing gear bracket with the longer bolts that are provided by AVSS. This spacer block can stay permanently attached to the aircraft and ensures that the DJI M300 RTK can still fit in the official DJI M300 RTK supplied hard case. The user must then enable the OSDK on the DJI M300 RTK to allow the FTS to work, which is done using DJI Assistant software.

2. General Use

To use the PRS-M300 for a flight, the DJI M300 RTK can be unpacked from its case and set up according to DJI's user manual. Once the aircraft is in its flight configuration, the AVSS bracket can be mounted to the DJI M300 RTK. The bracket side plates connect and lock into the spacer blocks. The bracket top plate which already has the electronics module and Parachute Pod™ attached can then be mounted and locked in place using a combination of a sliding motion and quarter turn fasteners. The provided FTS Module can then be plugged into the OSDK port on the DJI M300 RTK and connects to the electronics module using the provided cable that features locking connectors. The PRS-M300 is now fully installed. The PRS-M300 will turn on automatically when the DJI M300 RTK is turned on. The manual triggering device is turned on by the user to ensure that it is communicating with the PRS-M300. The manual triggering device has a secondary arm button that must be held down for two (2) seconds to arm the manual triggering device before the parachute can be manually deployed. Any error with the PRS-M300 will be communicated to the user via the manual triggering device in the form of verbal warnings and a status LED. During the flight, the PRS-M300 Autonomous Triggering System will arm itself only once it has reached the minimum deployable barometric altitude. Afterward, if the DJI M300 RTK experiences a failure, using a combination of accelerometer, gyro, and barometer data, the Autonomous Triggering System detects the failure, forces the motors to shutoff, and deploys the parachute without the need for pilot input. If the DJI M300 RTK experiences a flyaway, loss of communication, or other undesirable behavior, the pilot can manually trigger the parachute deployment to safely recover the aircraft.

Features, Specifications, Testing, & Compatibility

The PRS-M300 has been designed to easily integrate with DJI Matrice 300 RTK DJI M300 RTK. The attachment bracket secures the PRS-M300 without interfering with onboard sensors and can be easily removed for transport. The system includes an electronic module to power the Parachute Pod™ and flight termination system. The flight termination system is initiated when either the pilot instigates a deployment through the manual triggering device or when the Autonomous triggering system, using the onboard sensors located in the electronic module, determine that the DJI M300 RTK has breached the safe flying parameters. Once the flight termination system is initiated and stops the motors from spinning, the Parachute Pod™ is deployed and will result in the DJI M300 RTK descending under a fully inflated parachute.

1. Features

Attachment Bracket	The custom mounting bracket allows the PRS-M300 to be easily installed with minimal effort.
Independent Power Source	The PRS-M300 is equipped with an independent power source that allows the system to deploy if the DJI M300 RTK loses power.
Spring-Based Ejection	A high-energy spring is used to eject the parachute. This non-pyrotechnic system is safe for travel on commercial airlines.
Autonomous Trigger System	The Autonomous Triggering System (ATS) automatically detects failures and triggers the parachute release.
Manual Triggering Device	The manual triggering device can initiate deployment of the parachute recovery system at the discretion of the remote pilot in command.
Flight Termination System	Plug-and-play system that cuts power to the motors in the event of a failure and to ensure that the parachute does not become entangled in the DJI M300 RTK's propellers.
Audible Buzzer	An audible buzzer on the DJI M300 RTK will attempt to notify bystanders that the PRS-M300 has deployed and the DJI M300 RTK is descending.
Low Descent Rate	The parachute is designed to greatly reduce the descent velocity of the DJI M300 RTK in the event of a failure.
Flight Data Logging	Flight data logging to a dedicated microSD Card that is integrated in the PRS-M300.
Parachute Pods™	Easily replaceable Parachute Pod™.

2. Specifications

OVERVIEW³

Total Weight	922 grams (2.03 lbs)
Average Descent Rate (7.70 kg)	3.24 m/s (10.62 fps)
Average Descent Rate (9.20 kg)	3.54 m/s (11.61 fps)
Average Impact Energy (7.70 kg)	40.30 Joules (29.80 ft-lb)
Average Impact Energy (9.20 kg)	57.60 Joules (42.50 ft-lb)
Minimum Deployable Altitude (7.70 kg)	44.60 meters (146.33 ft)
Minimum Deployable Altitude (9.20 kg)	50.80 meters (166.67 ft)
Parachute Reuse Method	Prepacked Pods
Deployment Technology	Spring
Deployment Trigger	Manual and/or Autonomous

PARACHUTE RECOVERY SYSTEM

Main System Weight	650 grams (1.43 lbs)
Deployment Release Time	20 ms
Time to Inflation	0.57s to 1.30s
Battery Life	6 hours
Operating Temperature	-20°C to +45°C (-4°F to 113°F)

PARACHUTE POD™

Parachute Size	5.5m ²
Risers/Attachment Location	Internal

FLIGHT TERMINATION SYSTEM

FTS Method	OSDK
Integration Process	OSDK Port

ATTACHMENT BRACKET

Attachment Bracket Weight	272 grams (0.60 lbs)
Material	Carbon Fibre
Attachment Location	Top Mounted

Manual Triggering Device

Range	<2 km (<1.24 mi)
Frequency	915MHz (North America) / 868MHz (Europe)

³ Subject to change without warning based on supply chain material availability, payload selection, ongoing testing results, and environmental conditions.

3. Payloads

AVSS's PRS-M300 typically works with the various DJI M300 RTK payload options that are provided by DJI and that have been developed to integrate through the DJI OSDK Port. As of 2020-10-01, the following payload combinations, if using the user manual data located on DJI's and payload partners' website⁴, are within the 9.0kg Maximum Take-Off Weight criteria. Be aware, due to the potential unannounced changes by the supporting DJI M300 RTK and payload manufacturers, these charts are subject to change without any notification. The user is solely responsible for verifying the weight inaccuracies and calculating the weight of additional items attached to the DJI M300 RTK.

Single Payload Configuration Chart

Single Payload (KG)								
Drone	Battery	H20	H20T	Z30	XT S	XT2	U10 Methane	Z15
		0.686	0.833	0.556	0.387	0.629	0.534	.500
DJI M300 RTK	TB60	7.908	8.055	7.778	7.609	7.851	7.756	7.722
Available Weight (MaxTOW 9kg)		1.092	0.945	1.222	1.391	1.149	1.244	1.278

Dual Payload Configuration Chart

Dual Payload (KG)						
Drone	Battery	H20T + Z30	H20T + XT S	H20T + XT2	H20T + U10 Methane	H20T + Z15
		1.389	1.220	1.462	1.367	1.333
DJI M300 RTK	TB60	8.611	8.442	8.684	8.589	8.555
Available Weight (MaxTOW 9kg)		0.389	0.558	0.316	0.411	0.445

⁴ Please refer to [Appendix A: Drone & Payload References](#) for the complete list of references.

Warranty

- AVSS warrants that the PRS-M300 and its accessories are free from defects and fit for the operational purpose intended.
- The warranty period for the PRS-M300 is, the earliest of, twelve (12) months after purchase, or after three Parachute Pod™ deployments, which starts on the date listed as per the user's invoice from an Authorized Dealer.
- This warranty requires the PRS-M300 to be shipped to AVSS's location for analysis and may either be fixed, replaced and/or deemed voided of warranty at the sole discretion of AVSS.
- If the customer believes the PRS-M300 did not properly function or deployed the Parachute Pod™ in a non-failure event (False-Positive), the customer must send AVSS the following files:
 - PRS-M300 Data
 - DJI M300 RTK DAT data
 - DJI M300 RTK Text File
- If the PRS-M300 is deemed void, the cost of analysis and shipping shall be the responsibility of the end-user. Nothing herein contained shall be construed to exclude or limit any warranty, express or implied by law.
- AVSS hereby declares that the warranty shall be deemed void if the PRS-M300 is not used for the intended operational uses and/or if alterations, tampering, or any actions deemed comprising by AVSS, directly or indirectly, of the PRS-M300 This includes, but not limited to, non-standard use, the use of potentially disabling anti-operations technology, and/or unintended damage by the end-user.
- The manual triggering device for the parachute is warrantied against any manufacturing defect.
- The product warranty does not cover water damage.
- If the product is used or handled in any way otherwise described within this user manual, the warranty shall be void.
- The PRS-M300 purpose is to assist in decreasing the ground impact energy caused by the DJI M300 RTK mid-flight failure. The end-user cannot in any circumstances from AVSS pursue any compensation or allowance if their DJI M300 RTK is damaged.
- It is the responsibility of the purchaser to contact AVSS to obtain additional or updated copies of the user manual.

What's in the Box:

1. Parts Included

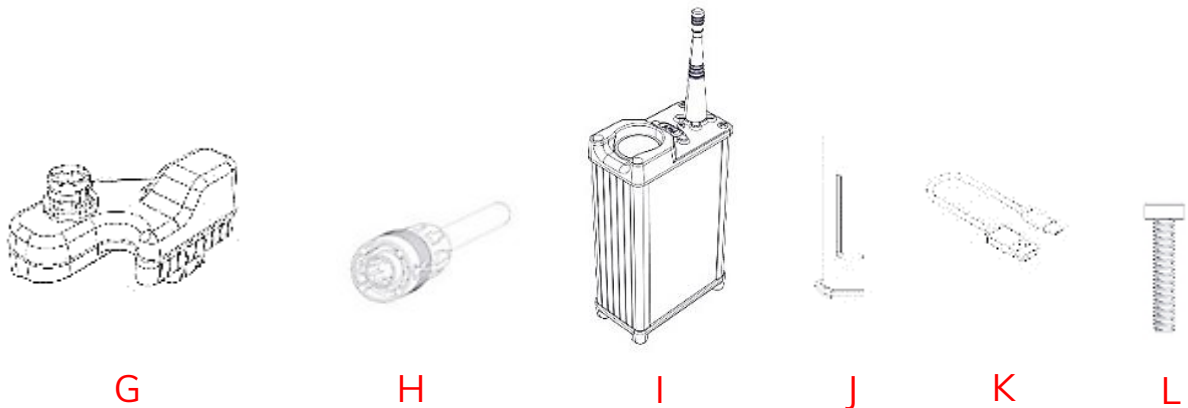
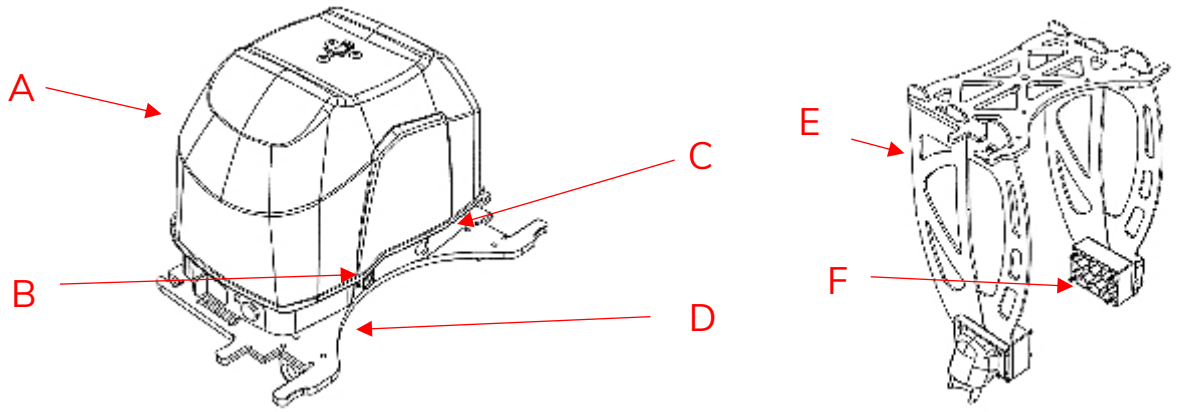

A. Parachute Pod™

B. FTS Connector

C. Electronic Module

D. Top Plate

E. Side Brackets (2)

F. Bracket Leg Connectors (2)

G. FTS OSDK Module

H. HR30 FTS Cable

I. Manual Trigger Device with Battery

J. Allen Keys

K. USB-C to USB-A Cable

L. M6 Bolt and Washer (2)

System Overview

1. Parachute Recovery System

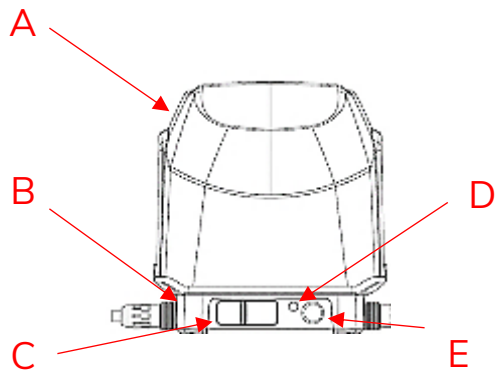

- A. Parachute Pod™
- B. Electronic Module
- C. MicroSD Dust Cap for the USB/microSD Card Slot
- D. Status LED
- E. Power Button

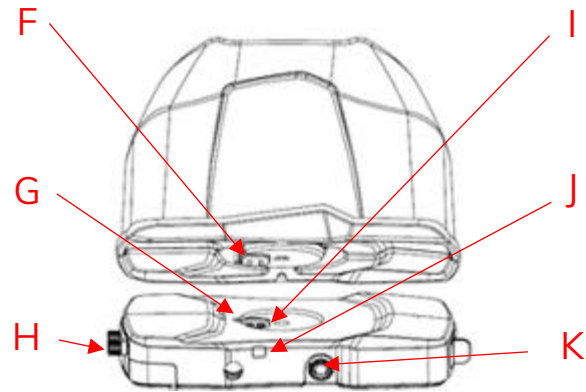

- F. Firing Pin Receptacles
- G. Orientation Key
- H. Battery Door
- I. Electrical Contacts
- J. Continuity LED
- K. HR30 FTS Connector

2. Attachment Bracket

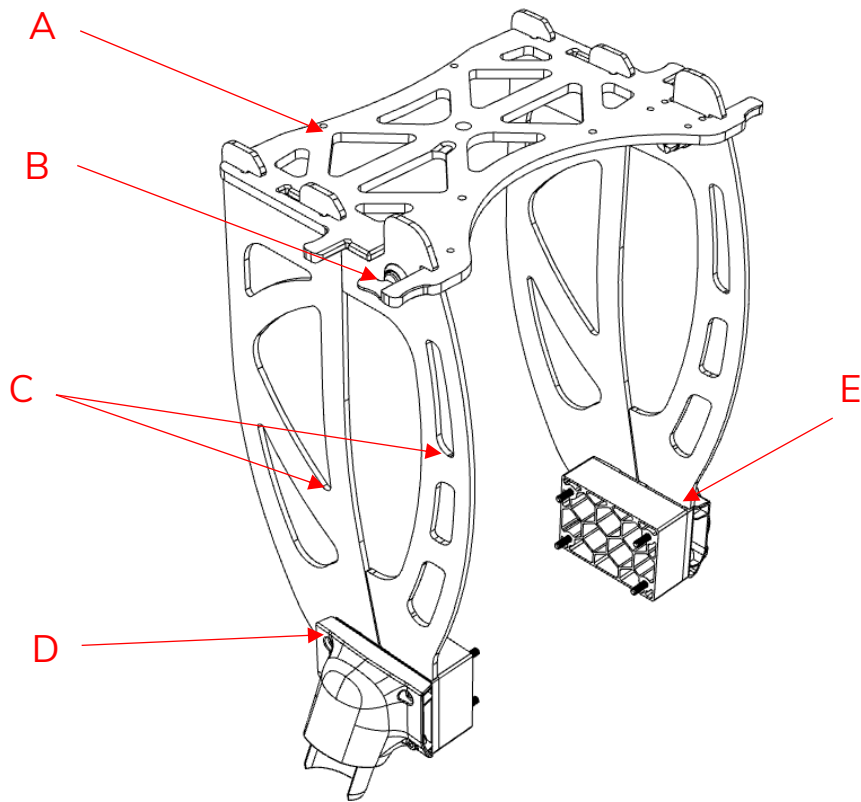

- A. Top Plate
- B. Quarter Turns (2)
- C. Side Plates (2)
- D. Landing Gear Screws (8)
- E. Bracket Leg Connectors

3. Flight Termination System – Through OSDK

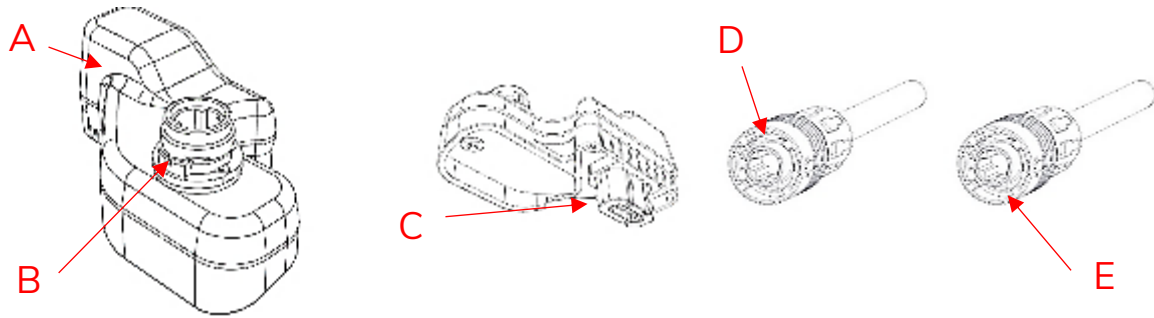

A. FTS OSDK Module

B. HR30 FTS Cable Female
Connector

C. USB-C Connector to DJI M300
RTK OSDK Port

D. HR30 FTS Cable to
Electronic Module
Connector

E. HR30 FTS Cable to FTS
Connector

4. Manual Triggering Device

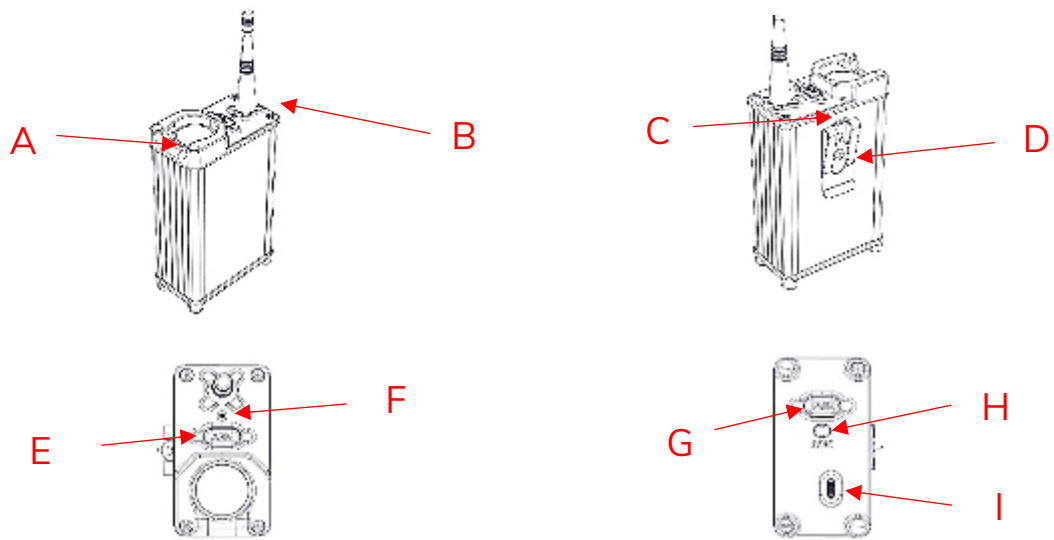

A. Triggering Button

B. Antenna

C. Lanyard Attachment

D. Belt Clip

E. Arm Button

F. Status LED

G. Power Button



H. Sync Button

I. USB-C Charging Port

Installation

⚠ ENSURE BOTH THE PRS-M300 AND DJI M300 RTK ARE OFF DURING INSTALLATION UNLESS REQUIRED FOR COMPLETING THE STEP.

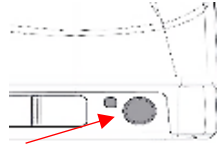
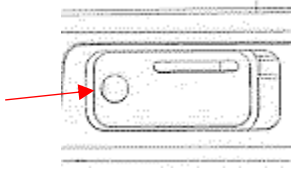
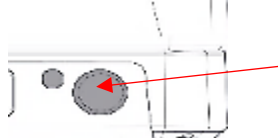





1. Electronic Module

Turning on the PRS-M300			
Step 1	Turn on System	To turn on PRS-M300, press on the ON/OFF switch.	
Synchronization on PRS-M300			
Step 1	Press and Hold Sync Button	To synchronize the PRS-M300, ensure the PRS-M300 is OFF. Next, pull the tab on the microSD dust cap cover to open it. Then, press and hold the small blue synchronization button in the top corner.	
Step 2	Turn On PRS	While holding the button, turn ON the PRS. The Main status LED should turn white after a moment.	
Step 3	Turn On Remote	Turn on the manual remote while holding the sync button that is located next to the power button. The LED on the remote will turn white.	
Step 4	Syncing	Once both the PRS and remote are on and in the sync mode (white LED), they will pair. The remote will indicate that the pair is connected and the status LED on both the PRS and the remote will green. The PRS and remote are now bound. They can now be turned off.	

2. Parachute Pod™

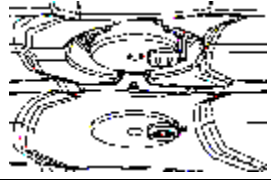
- 

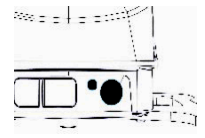
 • ONLY REMOVE THE PARACHUTE POD IF THE PARACHUTE HAS BEEN DEPLOYED.
- ENSURE THAT THE PRS-M300 IS OFF BEFORE REPLACING THE POD.

Attaching and changing the Parachute Pod™			
Step 1	Remove Parachute Pod™ from PRS-M300	Using the supplied hex key, unscrew the M6 bolt until the pod can be removed. Do not reuse the bolt and washer when attaching a new Parachute Pod™.	
Step 2	Align New Parachute Pod™	Remove the new Parachute Pod™ from its shrink wrap packaging. Align the Parachute Pod™ above the electronics module such that the electrical contacts will mate properly (as shown).	
Step 3	Press Parachute Pod™ Against Module	Press the Parachute Pod™ against the electronics module. The two shall mesh so that they do not slide against each other.	
Step 4	Slide Washer onto M6 Bolt	Take a new M6 bolt and slide on a new washer. The washer is slightly cone shaped. Ensure that the narrow end is towards the head of the bolt.	
Step 5	Tighten Bolt	Using the M5 hex key, tighten the bolt.	
Step 6	Power On	Place the PRS-M300 on a flat surface and turn on.	
Step 7	Check Continuity	Check that the continuity light on the side of the PRS-M300 is lit. This indicates that the electrical contacts are properly connected to the pod.	
Step 8	Power Off	Power off the module. The new Parachute Pod™ is now successfully installed.	

3. Attachment Bracket

First Time Use

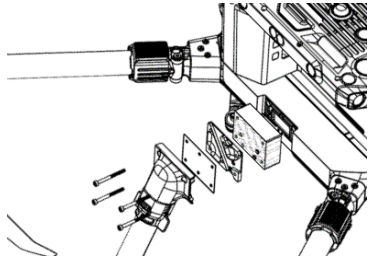
Bracket Leg Connectors for the DJI M300 RTK			
Step 1	Attachment Bracket Leg Connectors	<p>Unscrew and remove the M300 landing gear. Then, align the landing gear spacers to the bottom of the side brackets. Ensure the flat side of the spacers are attached to the side brackets and that the hollow middle is directed towards the M300 landing gear attachment point.</p>	
Step 2	Screw in Landing Leg Connectors	<p>Align the side brackets to the landing leg connectors and attach the landing gear to the outside of the side brackets. Then, screw in the provided landing gear bolts so that, in the following order, the screw is attached to the M300 landing gear, side brackets, spacers, and M300.</p>	



THE BRACKET SYSTEM SHALL BE FIRMLY ATTACHED. WHEN THE PARACHUTE DEPLOYS, THE PARACHUTE WILL TRANSFER THE ENTIRE WEIGHT OF THE DJI M300 RTK TO THE ATTACHMENT BRACKET.

Ongoing Use

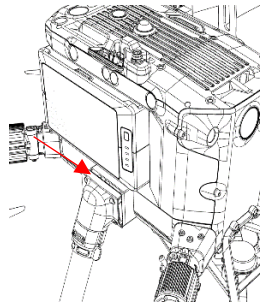
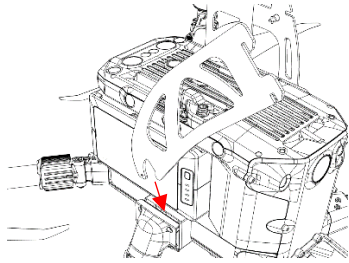
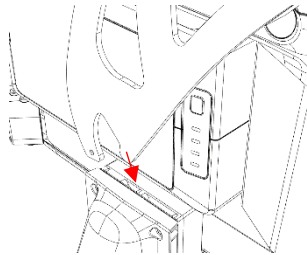
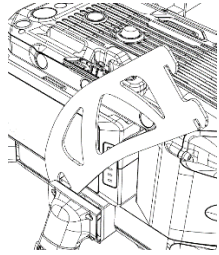
Installing the Attachment Bracket Before Use			
Step 1	Spacers Prepared	After completing the first time install steps, the DJI M300 RTK and PRS-M300 are ready to be attached for flight.	
Step 2	Rear Side Plate Alignment	Standing behind the drone, take the rear side plate as shown and ensure that the foam is on the inside, orientated towards the DJI M300 RTK.	
Step 3	Rear Side Plate Insertion	Align the heel of the bracket with the slot in the spacer block.	
Step 4	Rear Side Plates	Seat the heel into the slot to form a hinge.	

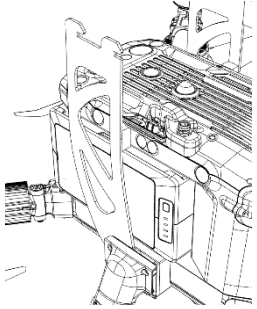
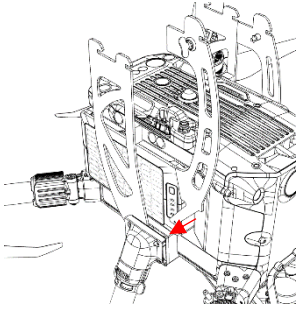
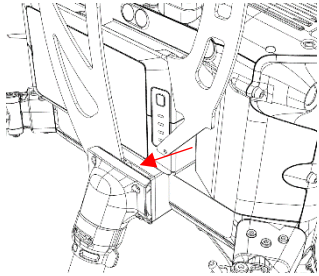
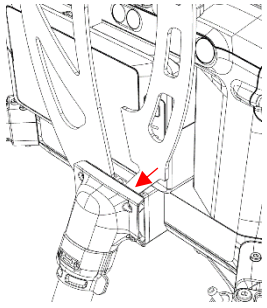
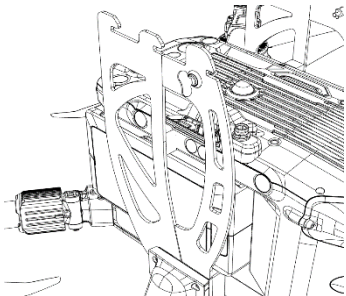

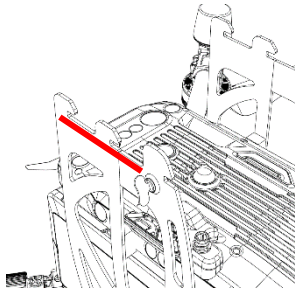
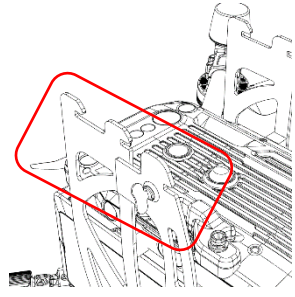
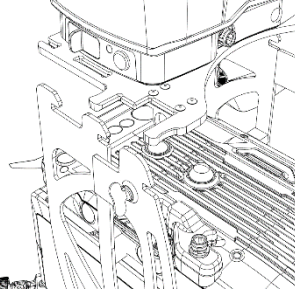
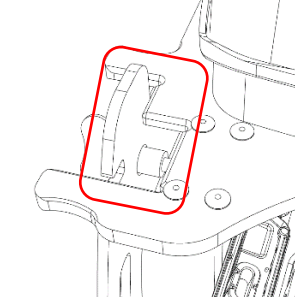
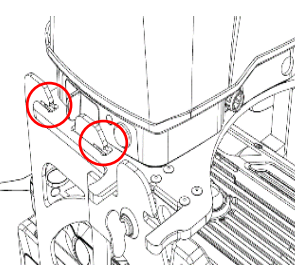
<p>Step 5</p>	<p>Rear Side Plates</p>	<p>Rotate the plate towards the back of the DJI M300 RTK until the hook latches into the block. A click should be felt/heard.</p>	
<p>Step 6</p>	<p>Front Side Plates</p>	<p>Take the front side plate and ensure the quarter turn twist tab is facing away from the drone as shown.</p>	
<p>Step 7</p>	<p>Front Side Plates</p>	<p>Align the tab at the bottom of the bracket with the slot located at the front of the spacer block.</p>	
<p>Step 8</p>	<p>Front Side Plates</p>	<p>Slide the tab into the slot. A click should be felt/heard when it is fully seated.</p>	
<p>Step 9</p>	<p>Front Sides Plates</p>	<p>The Side Plates are not installed. Repeat steps 1-9 for the other side.</p>	

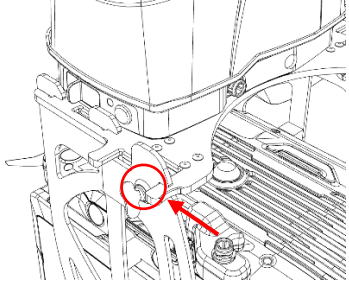
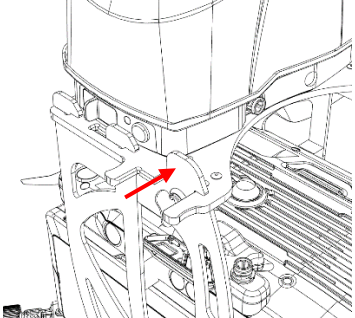
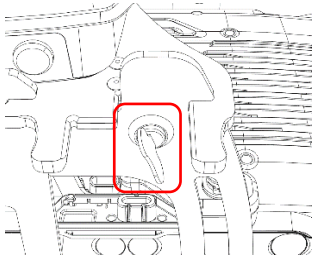
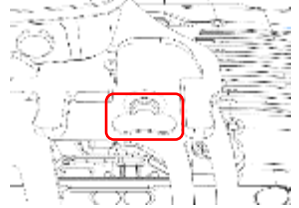
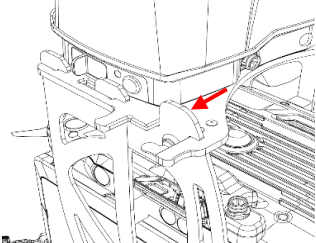
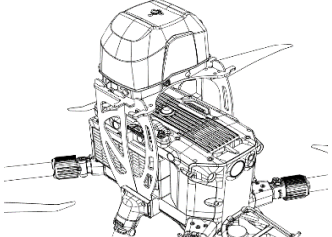
<p>Step 10</p>	<p>Top Plate</p>	<p>Ensure that both side brackets are fully inserted. The flat surface on which the top plate will rest should be flat.</p>	
<p>Step 11</p>	<p>Top Plate</p>	<p>Bend the front side plates outwards as shown.</p>	
<p>Step 12</p>	<p>Top Plate</p>	<p>Align the slots in the top plate with the side plate tabs.</p>	
<p>Step 13</p>	<p>Top Plate</p>	<p>Ensuring that the front side plates are still pushed out, lower the top plate onto the side plates.</p>	
<p>Step 14</p>	<p>Top Plate</p>	<p>The side plate tabs should pass through the slots in the top plate.</p>	

<p>Step 15</p>	<p>Top Plate</p>	<p>Push the top plate towards the back of the drone such that it locks with the hooks on the side plates.</p>	
<p>Step 16</p>	<p>Top Plate</p>	<p>Push the front side plate inwards so that it rests against the top plate. Both side plates should be aligned.</p>	
<p>Step 17</p>	<p>Top Plate</p>	<p>Once the side plate is pushed in towards the top plate, push the quarter turn in and rotate clockwise to lock.</p>	
<p>Step 18</p>	<p>Top Plate</p>	<p>The quarter turn tab should be horizontal once it is locked.</p>	
<p>Step 19</p>	<p>Top Plate</p>	<p>Pull outwards on the front side plate to ensure that the quarter turn is secured.</p>	
<p>Step 20</p>	<p>Top Plate</p>	<p>The bracket is now installed and ready for flight.</p>	

4. Flight Termination System Firmware Configuration

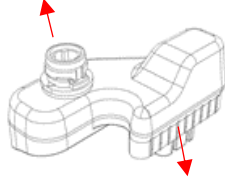
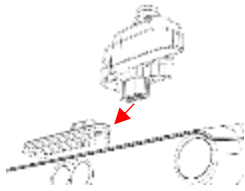
Ongoing Use

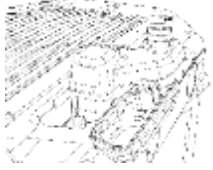
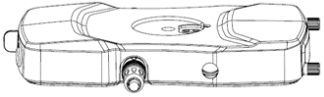
Connecting PRS-M300 FTS OSDK Module.			
Step 1	Open the DJI M300 RTK OSDK Port	Open OSDK port.	
Step 2	Orient the PRS-M300 FTS OSDK Module	Align the PRS-M300 FTS OSDK Module so the HR30 Connector is pointing up.	
Step 3	Align the PRS-M300 FTS OSDK Module	Align the PRS-M300 FTS OSDK Modules USB-C to the DJI M300 RTK OSDK port and is facing the correction orientation with the HR 30 connector closer to the front of the DJI M300 RTK.	
Step 4	Connect the PRS-M300 FTS OSDK Module	Gently, but firmly, connect the PRS-M300 FTS OSDK with the DJI M300 RTK OSDK port.	
Step 5	Plug in the PRS-M300 FTS OSDK Module to the DJI M300 RTK	Ensure the PRS-M300 FTS OSDK module is securely plugged in.	
Step 6	Connect HR30 FTS Cable to Electronic Module and FTS OSDK Module	Use the HR30 FTS cable to connect the FTS interface on the left side of the PRS-M300 and the FTS OSDK Module.	



- VERIFY THAT THE OSDK APP HAS BEEN ACTIVATED.
- VERIFY THAT ALL HARDWARE CONNECTIONS ARE SECURED.

First Time Use & After Firmware Updates

The PRS-M300 uses the DJI M300 RTK Onboard SDK (OSDK) to instigate flight termination. The flight termination system shuts off the DJI M300 RTK motors prior to the deployment of the Parachute Pod™. This installation section provides the steps to correctly configure and activate the DJI M300 RTK OSDK App using DJI Assistant 2 (Enterprise). These steps must be completed prior to first time use, and after updating the firmware on the DJI M300 RTK.

Configure the OSDK in DJI Assistant 2		
Step 1	Before Starting	<p>To complete this configuration using DJI Assistant 2 (Enterprise), an internet connection is required. Download and install DJI Assistant 2 (Enterprise) if it is not already installed.</p> <p>The PRS will need to be installed on the DJI M300 RTK. Please keep the hardware connection described on page 26. You will also need the manual remote to verify the status.</p>
Step 2	Plug in USB-C Cable	<p>Plug in the USB-C cable to the Assistant Port located on the right side of the drone. Connect the other end of the cable to your computer.</p>

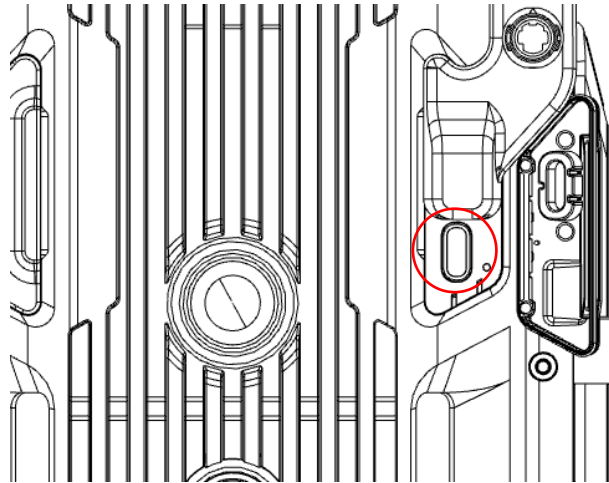

Step 3	Launch DJI Assistant 2	Launch DJI Assistant 2 (Enterprise).
-----------	------------------------	--------------------------------------





Step 4	Log in to DJI Assistant 2	Log in to your DJI Account. If you do not have an account, you will need to create one.
-----------	---------------------------	---

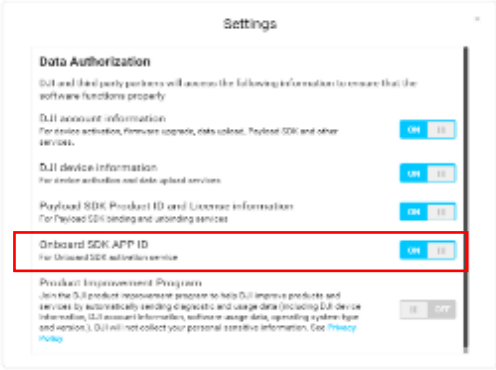
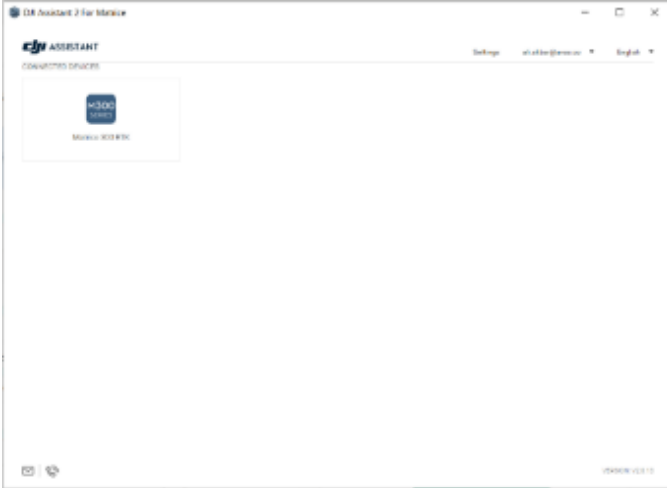

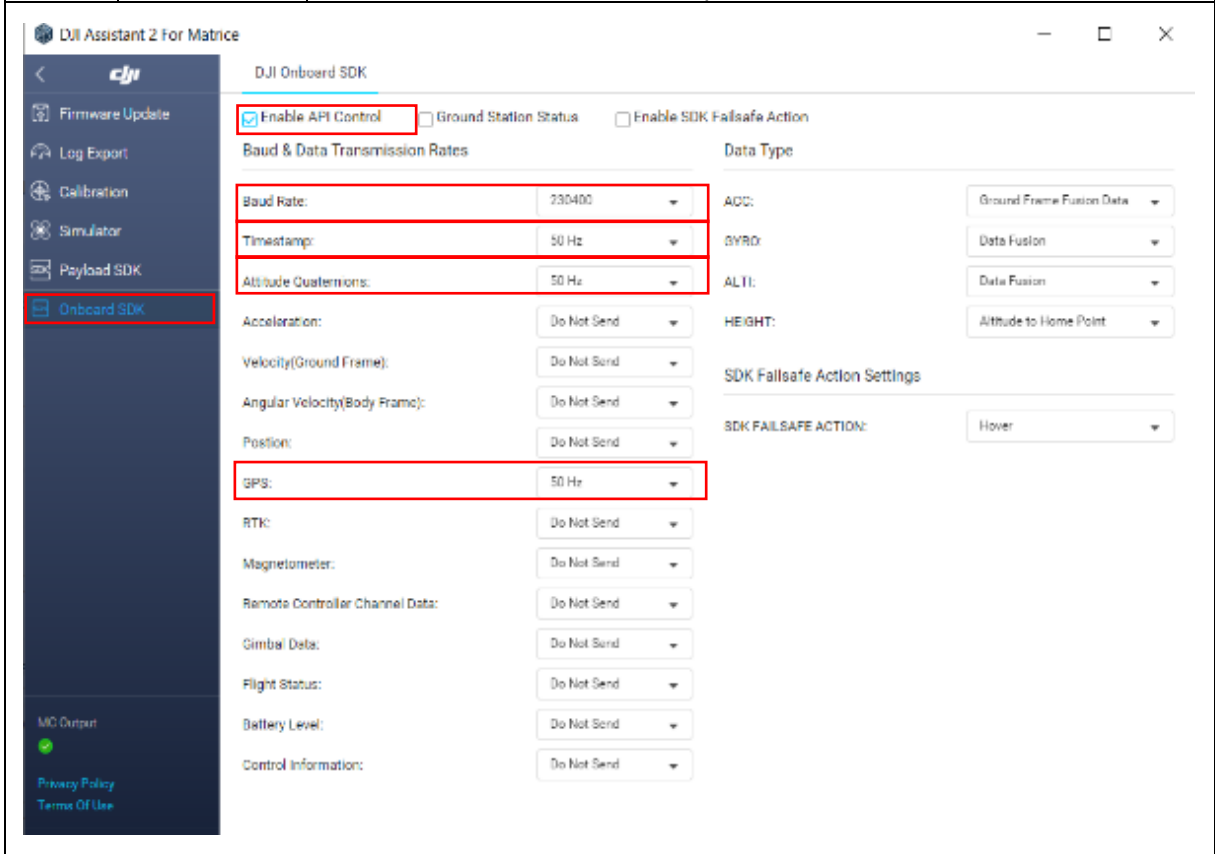

<p>Step 5</p>	<p>Configure Settings</p>	<p>Open the settings tab in the top right of the window. Configure the data authorization settings to allow for data authorization of the Onboard SDK APP ID. Turn on the authorizations as shown.</p>
<div style="text-align: center;">  </div>		
<p>Step 6</p>	<p>Turn on DJI M300 RTK and PRS</p>	<p>Turn on your DJI M300 RTK. Verify that the PRS is on. It should power on automatically when the DJI M300 RTK is turned on. If it does not turn on automatically, ensure that the FTS Module and FTS Cable are connected properly. The LED on the PRS will blink purple and blue when the FTS is plugged in but not yet configured.</p>
<p>Step 7</p>	<p>Turn on Remote</p>	<p>Turn on the manual trigger remote. This will allow you to verify the status of the FTS.</p>
<p>Step 8</p>	<p>Connect to Drone</p>	<p>Once the drone is on, the DJI Assistant 2 app will recognize that the Matrice 300 RTK is available. Click on the icon to connect to the drone.</p>
<div style="text-align: center;">  </div>		

Step 9	Configure DJI M300 RTK OSDK	<p>Select the “Onboard SDK” tab from the left side menu. In this new window, complete the following:</p> <ul style="list-style-type: none"> • Select “Enable API Control” via checkbox on the top left. • Set “Baudrate” to 230400 via dropdown list. • Set “Timestamp” to 50 Hz via dropdown list. • Set “Attitude Quaternions” to 50 Hz via dropdown list. • Set “GPS” to 50 Hz via dropdown list.
-----------	-----------------------------------	---

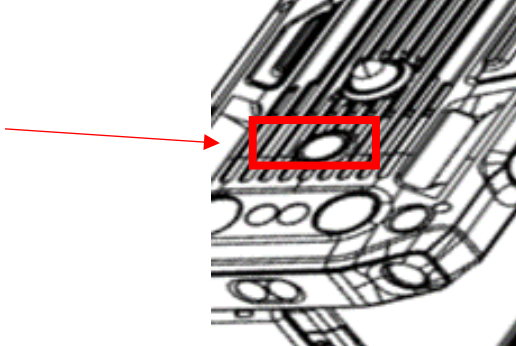

 Note: If this is not the first time completing these steps on this drone and you are simply re-configuring the FTS as a result of a firmware update to the DJI M300 RTK, the LED on the PRS may turn green at this stage. In this case, the setup is complete. If this is the first time configuring the FTS on this drone, OR the LED does not turn green, proceed to the next step.

Step 10	Turn Off PRS and Drone	Turn off the PRS. Once complete, turn off the DJI M300 RTK.
		
Step 11	Close DJI Assistant 2	Once the PRS and DJI M300 RTK are off, close DJI Assistant.
Step 12	Launch DJI Assistant 2	Re-launch DJI Assistant 2.
		
Step 13	Turn on Drone and PRS	Turn on the DJI M300 RTK. Verify that the PRS is on. The PRS should turn on automatically.

Step 14	Reconnect to Drone in DJI Assistant 2	Once again, the DJI Assistant 2 app will recognize that the DJI M300 RTK is available. Click on the icon to connect to the drone.
---------	---------------------------------------	---

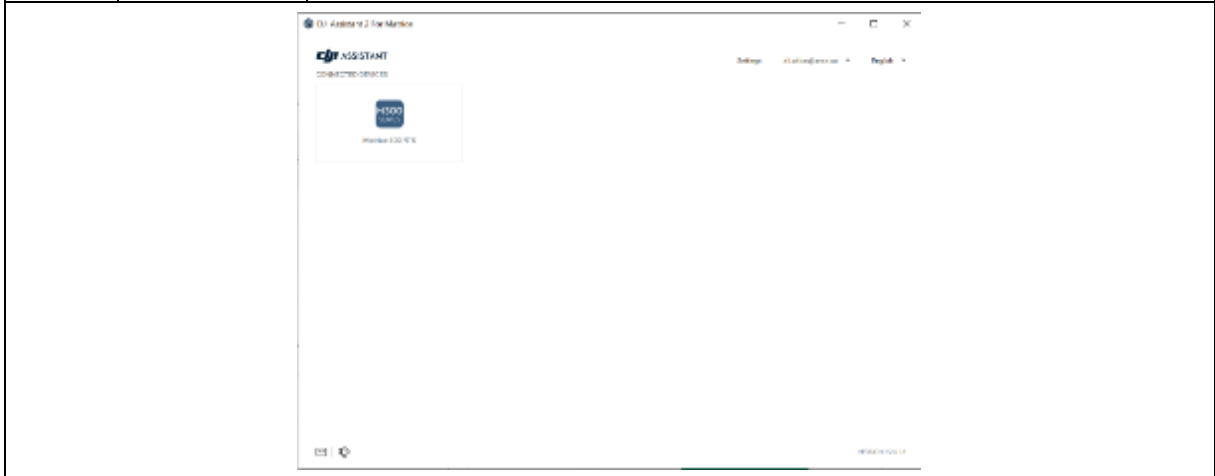

Step 15	Verify Settings	<p>Return to the Onboard SDK tab using the left side menu. Verify that the correct settings were saved.</p> <ul style="list-style-type: none"> • The “Enable API Control” checkbox on the top left should be checked. • “Baudrate” should be set to 230400. • “Timestamp” should be set to 50 Hz. • “Attitude Quaternions” should be set to 50 Hz. • “GPS” should be set to 50 Hz.
---------	-----------------	---

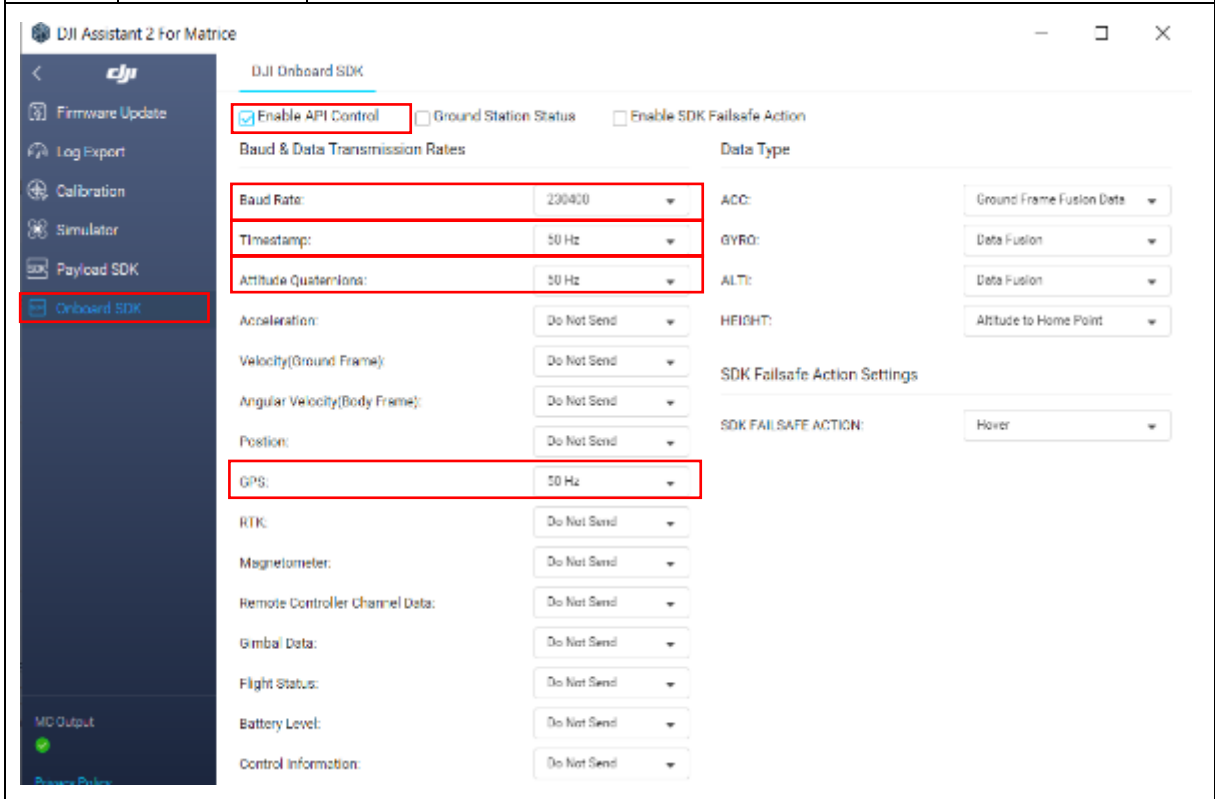

Step 16	Cycle PRS Power	Turn the PRS OFF. Wait a moment and then turn the PRS back ON. After a moment, the LED will blink purple and blue.
Step 17	Cycle PRS Power Again	Turn the PRS OFF. Wait a moment and then turn the PRS back ON. Now the LED on the PRS should turn green once it has finished initializing. Once the LED is green, the FTS has been properly configured and is ready to use.

 The LED will turn yellow if the manual trigger remote is not connected.

Step 18	Process Complete	Once the LED on the PRS is green, the setup process is complete. Turn off the PRS, drone and manual remote in that order. The USB-C can now be unplugged from DJI assistant. Don't forget to reinstall the small silicon cover to protect the Assistant Port during flight.
------------	---------------------	---



- MAKE SURE ALL CONNECTORS ARE PROPERLY ATTACHED TO THE FLIGHT TERMINATION SYSTEM AND PRS-M300.
- DO NOT LEAVE METAL TERMINALS EXPOSED TO OPEN AIR WHEN NOT IN USE.

Battery & Charging

1. Battery Safety

- The PRS-M300 is equipped with an independent 1S LiPO battery to supply power.
- The PRS-M300 shall be charged before use and only by an AVSS supplied or approved USB-C Cable.
- The batteries nominal voltage is 3.7
- Failure to comply may result in damage to the battery, the PRS-M300, severe overheating, and/or fire.
- If left in unsuitable environments, the system and/or components may be damaged, the warranty will shall be void, and the items may not properly function.
- During charging, keep watch on the charging process and react to any potential problems that may occur.
- Never leave unprotected charging batteries unattended.
- The battery should be replaced at maximum every two years.







DO NOT TAKE OFF WHEN THE BATTERY INDICATOR IS RED.

2. Battery Charging

Battery Indications





- The battery charge status on both devices, the manual triggering device and the electronic module, can be checked by pressing the synchronization (“Sync”) button after the startup sequence is finished. The battery colors are the following:

LED Color	 (red)	 (yellow)	 (green)	 (white)
Battery %	0-25	25-50	50-75	75-100

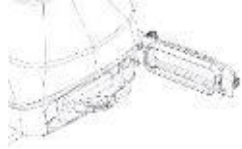

THE PRS-M300 HAS BUILT-IN CHARGING CIRCUIT TO MAINTAIN AN ADEQUATE LEVEL OF POWER, WHICH WILL GATHER POWER FROM THE DJI M300 RTK BATTERIES THROUGH THE FLIGHT TERMINATION SYSTEM WHEN THE PRS-M300 BATTERY LEVEL IS LESS THAN 20%.

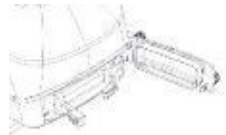
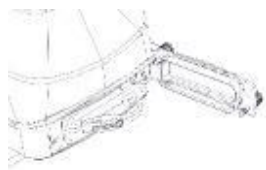
3. Changing Electronic Module Battery

Replacing PRS-M300 Battery			
Step 1	Turn the Battery Knobs	Using the knob, turn the knobs to open the battery compartment door.	
Step 2	Open Battery Door	Using the knob, turn and open the battery compartment door.	
Step 3	Disconnect battery connector	Press the release on the battery connector and unplug the cable.	
Step 4	Remove Battery	Slowly remove battery from storage compartment.	
Step 5	Orient Battery and Cable	Orient the new battery so that the cable is as shown in the corner.	
Step 6	Plug-in Battery	Plug-in the battery connector to the cable inside the battery compartment of the electronic module. Proper attachment will result in a “click” sound and will be latched.	
Step 7	Close Battery Door	Once the battery and cable are neatly packed into the compartment, close the battery door and tighten knob. Ensure that the cable is not being pinched by the door.	

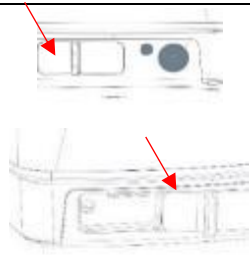
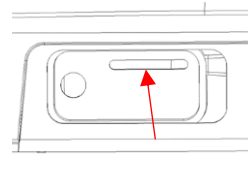
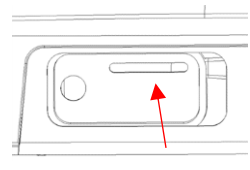

Firmware & SD Card

1. MicroSD Card

Removing and/or Inserting the SD Card			
Step 1	Open Door	Pull the tab on the charging port cover to open it. The tab will open with a hinged door that opens to the right, towards the power button.	
Step 2	Remove SD card	Gently press the SD card in to release the latch and then pull the card out of the slot. Use Tweezers if necessary.	
Step 3	Insert Micro SD-Card	To insert the micro SD-card, slide it into the slot with the metal contacts facing up. An audible click should be heard when it connects properly.	

2. Firmware Updates

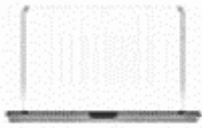
Firmware updates should be performed when a new version is released by AVSS. Check the AVSS website regularly for firmware updates.

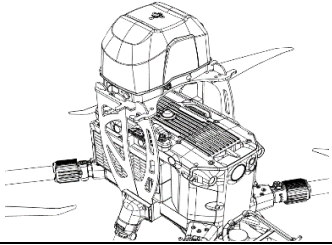
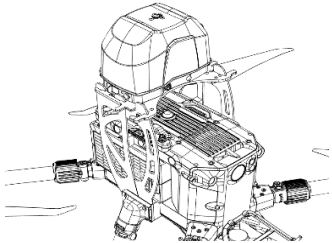
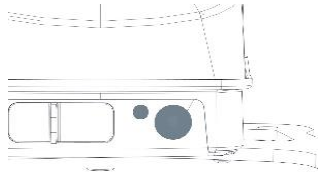
Updating the Firmware			
Step 1	Download firmware	Download the firmware from the bottom of the page on https://www.avss.co/products/prs-for-dji-m300-rtk/	
Step 2	Copy the firmware on a SD card	Copy the firmware on a SD card and insert in the PRS-M300, there may be 3 firmware files if this is a major release (PRS-M300, Remote, Daughterboard). Do not change the file names of the Firmware.	
Step 3	Connect FTS of PRS-M300 to the DJI M300	Ensure that the drone, PRS-M300, and Manual Remote are all turned off. Connect the FTS cable on the PRS-M300 to the DJI-M300.	
Step 4	Turn on DJI M300 drone	Turn on the drone, which should automatically turn on the PRS-M300, if not, turn on the PRS-M300 by clicking the main PRS-M300 button, next to the status LED.	
Step 5	Firmware LED	The PRS-M300 LED should turn white to indicate the firmware is downloading. Then the LED should be pink to indicate updating, and then the LED will turn white again to download the next firmware. Wait till the PRS-M300 LED turns yellow , indicating a successful firmware update for the PRS-M300 and daughterboard.	

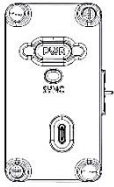
<p>Step 6</p>	<p>Turn on the manual remote</p>	<p>Keep the remote at least 2 meters away from the DJI M300, then turn on the remote. The remote firmware will now update and the LED should be white. When the firmware is successfully updated the PRS-M300 and remote LED should be green.</p>	
---------------	----------------------------------	---	---

 LED TURNS OFF WHILE INSTALLING THE NEW FIRMWARE. DO NOT POWER OFF THE MODULE UNTIL THE LED INDICATOR COMES BACK ON.

Status Indications

The PRS-M300 status, also referenced as “Heartbeat” is indicated using a combination of LED color and buzzer signals. The PRS-M300 Status LED is located next to the ON/OFF switch. The LED color on PRS-M300 and manual triggering device indicates the stage of the flight. The manual triggering device LED indicates its state for 2 seconds and blinks the color of the PRS-M300 when a connection is established. The buzzers indicate secondary information which can be either continuous and require action or show a single event for user information.

1. PRS-M300 Indications

#	Status	LED ⁵ / Buzzer ⁶	Required action
1	Power on		
2	Synchronization		Hold Sync and turn on the manual triggering device
3	Updating firmware		See firmware section
4	Initializing		
5	FTS not connected		Connect the HR30 FTS cable to pass initialization ⁷
6	FTS diagnostic failed		Change FTS module or HR30 FTS cable
7	Initialized		
8	POD not found		Install/replace the pod
9	Very low battery (~1 hour ⁸)		Replace/charge the battery
10	SD error		Ensure SD card is readable and properly inserted
11	Searching for RF		Turn on the manual triggering device (make sure it is bound)
12	Standby		SD card Error, ready to take off
13	Standby		Ready to take off (No error)
14	ATS Armed		ATS is active, SD error
15	ATS Armed		ATS active (No error)
16	FTS activated		Immediate deployment, keep away

⁵ Purple, Blue, Yellow, Red, Cyan, Green, Off

⁶ Buzzer is illustrated by lines around the color marks

⁷ Disconnection of the FTS after the initialization produces the same error and needs a power cycle to run diagnostic again

⁸ Dependent on environmental factors and number of battery charge cycles

17	Sensor Error		Check Event log on the SD card. IMU calibration may be required.
----	--------------	--	--

2. Manual Triggering Device Status Indication

The LED on the manual triggering device indicates its status for 2 seconds and blinks the status of the PRS-M300 so the pilot can monitor the status of the PRS-M300 in the sky conveniently.



The manual triggering device status has the following colors:

Synchronizing	W
Searching	Y
Standby	G
Armed	C
Critical/Triggered	R

3. Manual Triggering Device Synchronization

1. Make sure that both devices are off.
2. Hold the Sync button on the manual triggering device and, while turning it on, until the LED turns white.
3. To increase the channel, press and hold the arm button until the LED turns off then release. Repeat to increase the channel further. Number of channels depends on the local regulations.
4. Hold the Sync button on the PRS-M300 and while turning it on. The LED should be white.
5. Hold the Sync button on the manual triggering device and turn it on.
6. Both devices will generate a tone and Sync.
7. Note, the manual triggering device can also change channels. This feature can be used to potentially reduce RF interference. To change the manual triggering device channel, the user should contact customersupport@avss.co.

 ONCE A DEVICE IS PUT TO SYNC MODE, IT WILL SYNCHRONIZE WITH THE FIRST DEVICE IT FINDS. TO PREVENT UNINTENDED SYNCHRONIZATION, SYNCHRONIZE ONLY A SINGLE PRS-M300 AND A SINGLE MANUAL TRIGGERING DEVICE AT THE SAME TIME.

Operating Procedures

1. Hangar Checklist

- Make sure manual triggering device battery is fully charged
- Make sure the electronic module battery is charged more than 25%
- Make sure that the memory card is inserted and has enough storage space

2. Installation Checklist

- Ensure that the PRS-M300 and bracket are not damaged
- Ensure the foam spacers are still secure to the bracket
- Insert Attachment Bracket legs, two per side, to the bracket leg connectors
- Ensure that the PRS-M300 top plate and main system are securely attach
- Verify that bracket is secure to the DJI M300 RTK
- Check that the FTS connectors on the electronics module, FTS module and cable are clean and undamaged
- Plugin HR30 FTS cable to FTS module
- Passing under the landing gear leg, plug the HR30 FTS cable into the electronics module
- Ensure that the HR30 FTS cable is securely connected and cannot interfere with propellers
- Check that manual triggering device antenna is oriented vertically

3. Pre-Flight Checklist

- Perform DJI M300 RTK Preflight checks
- Ensure DJI M300 RTK is in position mode
- Connect the HR30 FTS cable with PRS-M300 electronic module
- Turn on PRS-M300 Manual Triggering Device
- Turn on PRS-M300 by turning on the DJI M300 RTK
- Check continuity light
- Check the buzzers and lights (heartbeat)
- Check battery level and ensure it is at least 50%
- Wait for successful initialization
- Ensure no errors are present
- Move at least 5 meters away from the DJI M300 RTK
- Arm the manual triggering device by holding down the “Arm” button for about 2 seconds and will provide audio feedback with the statement of “Remote Armed”
- Takeoff and climb to minimum deployable altitude

 **AUTO-TRIGGER WILL ONLY ARM ONCE AN ALTITUDE OF 43 METERS IS REACHED.**

4. In-Flight Checklist

- Always fly in Position Mode
- Fly in a safe and controlled manner
- Avoid flying over people if unnecessary

5. Landing Checklist

- Land DJI M300 RTK gently on a level surface a safe distance from people
- Do not approach DJI M300 RTK until the ATS is disarmed, which will take approximately 5 seconds. Note, the pilot will be notified through a voice command on the manual triggering device
- Disarm manual triggering device
- Turn off the PRS-M300 once it has landed
- After the PRS-M300 is off, turn off the DJI M300 RTK

6. Post-Flight Checklist (No Deployment)

- Ensure PRS-M300 is disarmed before approaching the DJI M300 RTK
- DO NOT STAND DIRECTLY OVER THE PRS-M300 WHEN APPROACHING THE DJI M300 RTK
- Turn off PRS-M300 BEFORE handling the DJI M300 RTK
- Turn off the DJI M300 RTK
- Disconnect HR30 FTS cable before removing batteries
- Inspect PRS-M300 for damage

7. Deployment Checklist

- If necessary, the system can be deployed using the manual triggering device
- If possible, fly over a safe area free of people, cars or obstacles
- Press and hold the trigger button on the manual triggering device
- Visually follow the DJI M300 RTK's descent to the ground

8. Post-Flight Checklist (With Deployment)

- Hold parachute by the lines and fold canopy to prevent wind from inadvertently inflating the parachute
- Turn off PRS-M300
- Turn off DJI M300 RTK
- Disconnect PRS-M300 and bracket from the DJI M300 RTK
- Verify that no components are missing

Maintenance & Care

Maintenance and inspection intervals of the AVSS PRS-M300 are required to maximize the safety of each flight and ensure proper functionality for parachute deployment whenever it may be required. The PRS-M300's Electronic Module is expected to reliably function for several parachute deployments so long as no damage is imparted to the module. The PRS-M300's Parachute Pod™ is intended as a single-use item that can be quickly removed and replaced in the field; however, the PRS-M300 must be repacked in one (1) year intervals.

1. Post-Flight (Monthly)

1. Visually inspect the PRS-M300 to ensure there is no damage
2. Test the receptacles on the Electronic Module and Parachute Pod™
3. Test the manual triggering device

2. Transportation

1. Always transport in a secure storage case

3. Storage

1. Always ensure the power is off
2. Make sure the unit is clean and dry before putting in the case

4. Extended Storage Considerations

1. Store in a dry room, that is room temperature
2. Uninstall the AVSS PRS-M300 assembly down to the following separate components:
 - a. PRS-M300 Electronic Module
 - b. PRS-M300 Parachute Pod
3. Visually inspect the electrical connectors located on both the Electrical Module and the Parachute Pod. Check against signs of corrosion, dust/dirt buildup, wear, or any other types of abnormalities. Clean electrical contacts with rubbing alcohol and cotton swabs if necessary.
4. Inspect the Main Parachute and harness lines for:
 - a. Signs of moisture such as standing water or mold
 - b. Tears, rips, fraying and other signs of wear and damage
5. If any of the above defects are present during the annual inspection, contact AVSS for further information.

Frequently Asked Questions

1	How do I register my PRS-M300?	Go to https://www.avss.co/products/product-registration/
2	When does the ATS Arm?	43 meters
3	When does the Manual Triggering Device Arm?	By the pilot initializing the manual triggering device through the “arm” button
4	When does the PRS-M300 return to a standby state?	After landing for 5 to 10 seconds and then the user will receive audio feedback that it has returned to the standby state
5	How many files can the microSD card hold?	Erase microSD card files after 200 flights
6	How do I check the power level on the electronic module?	Push the blue Sync button, located behind the microSD dust cap on the electronic module, on the PRS-M300 to check the power level

Parachute Pod™ Deployment Procedures

The Parachute Pod™ must be repacked annually. To return a used and/or unused Parachute Pod™, an end-user may do so by sending the Parachute Pod™ directly to AVSS or by returning the Parachute Pod™ to their Authorized Dealer.

Sending to AVSS:

- Before sending the Parachute Pod™ to AVSS, contact customersupport@avss.co to request a shipping label.
- If you are purchasing a new Parachute Pod™, AVSS will send you a purchase link for a replacement Parachute Pod™, plus deposit.
- Once fully paid, AVSS will then send you the replacement Parachute Pod™.
- To return your Parachute Pod™ and receive your deposit, utilize the same box with the provided shipping label to send the Parachute Pod™ to AVSS.
- Once AVSS receives the Parachute Pod™ and completes the visual inspection, you will be notified and will receive your deposit within fourteen business days.

Sending to an Authorized Dealer:

- Contact your Authorized Dealer to notify them that you will be returning and/or requesting a new Parachute Pod™
- If you are purchasing a new Parachute Pod™, the Authorized Dealer will either send you a purchase link for a replacement Parachute Pod™, plus deposit, or accept payment at their physical location.
- Once fully paid and your Parachute Pod™ has been returned, the Authorized Dealer will then send you or directly provide you with the replacement Parachute Pod™.

Customer Support



Email: customersupport@avss.co
Telephone: Monday to Friday, excluding holidays
10:00 am Est to 4:00 pm Est
+1-844-852-0665



Appendix A: DJI M300 RTK & Payload References



Drone / Payload	Date	Link
DJI M300 RTK	2020-09-01	https://dl.djicdn.com/downloads/M300/20181120R/Matrice_200_User_Manual_v1.4_EN.pdf
DJI H20	2020-09-01	https://www.dji.com/ca/zenmuse-h20-series/specs
DJI H20T	2020-09-01	https://www.dji.com/ca/zenmuse-h20-series/specs
U10 Methane	2019-10-09	https://terra-1-g.djicdn.com/851d20f7b9f64838a34cd02351370894/others/EN-a5_U10%20Gas%20Detector_en_format_191009.pdf
Wingsland Z15	2019-09-16	https://terra-1-g.djicdn.com/851d20f7b9f64838a34cd02351370894/others/Z15_Spotlight_en.pdf
Zenmuse XT	2016-07-11	https://dl.djicdn.com/downloads/zenmuse_xt/en/Zenmuse_XT_User_Manual_V1.2_en_0708.pdf
Zenmuse XT 2	2018-05-11	https://dl.djicdn.com/downloads/Zenmuse%20XT%202/Zenmuse%20XT%202%20User%20Manual%20v1.0_.pdf
Zenmuse Z30	2018-10-08	https://dl.djicdn.com/downloads/zenmuse_z30/20180810/Z30_User_Manual_EN.pdf

Appendix B: IMU Calibration Instructions

A red flashing LED and a beeping sound coming from the PRS-M300 indicates that the IMU must be calibrated. There are two methods of calibrating the IMU on the PRS-M300, either by placing the PRS-M300 in the travel box or keeping the PRS-M300 on the drone. The preferred method is in the box; however, if the box cannot be located, performing the calibration on the drone is acceptable.



PRS-M300 IMU Calibration in the box		
<p>Step 1</p>	<p>Remove the PRS-M300 from the brackets on the drone, but do not remove the module from the base plate.</p>	
<p>Step 2</p>	<p>Turn the PRS-M300 on and lay it on the PRS box, keeping it stationary for a couple of seconds until the LED flashes red and the PRS-M300 starts beeping.</p>	
<p>Step 3</p>	<p>Place the PRS-M300 in its position in the PRS-M300 box.</p>	



<p>Step 4</p>	<p>Close the box.</p>	
<p>Step 5</p>	<p>Rotate the box 90 degrees towards the latched end and allow the box to stand on this end for 5 seconds.</p>	
<p>Step 6</p>	<p>Rotate the box 90 degrees in the opposite direction and allow it to stand on this end for 5 seconds.</p>	

<p>Step 7</p>	<p>Bring the box back to the original position and rotate it to the right side 90 degrees and wait for 5 seconds.</p>	
<p>Step 8</p>	<p>Bring the box back to the original position and rotate it to the left side 90 degrees and wait for 5 seconds.</p>	
<p>Step 9</p>	<p>Bring the box back to the original position and leave it stationary for 20 seconds.</p>	
<p>Step 10</p>	<p>If the calibration is successful three beeps will start from the PRS-M300 and the PRS will auto shutdown in 5 seconds.</p>	<p>If the calibration is unsuccessful the LED will continue to flash and the beeping will sound, go back to step 2 and re-calibrate.</p>

If the calibration is successful, the PRS LED will flash pink and blue, and the module is ready to fly.

If the travel box cannot be found and calibration is needed, then use the following method on the drone.

PRS-M300 IMU Calibration on the Drone		
Step 1	Remove the props from the drone and keep it on a level surface.	
Step 2	Turn on the PRS-M300. The PRS-M300 should be beeping and flashing red	
Step 3	Tilt the drone backward 90 degrees. Hold steady for 5 seconds.	

<p>Step 4</p>	<p>Bring the drone back to level and then tilt it forward 90 degrees. Hold steady for 5 seconds.</p>	
<p>Step 5</p>	<p>Bring the drone back to level and then tilt it towards the right 90 degrees. Hold steady for 5 seconds.</p>	
<p>Step 6</p>	<p>Bring the drone back to level and then tilt it towards the opposite side 90 degrees. Hold steady for 5 seconds.</p>	

<p>Step 7</p>	<p>Bring the drone back to level and leave it for 20 seconds.</p>	
<p>Step 10</p>	<p>If the calibration is successful three beeps will start from the PRS-M300 and the PRS-M300 will auto shutdown in 5 seconds.</p>	<p>If the calibration is unsuccessful the LED will continue to flash and the beeping will sound, go back to step 2 and re-calibrate.</p>